

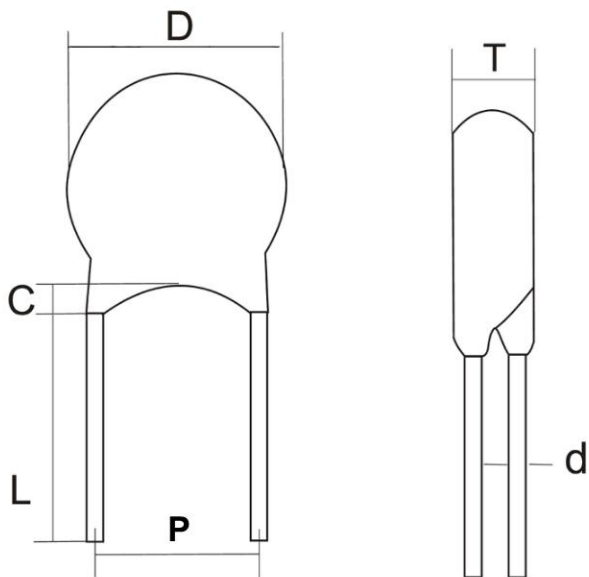

### Lead Styles:

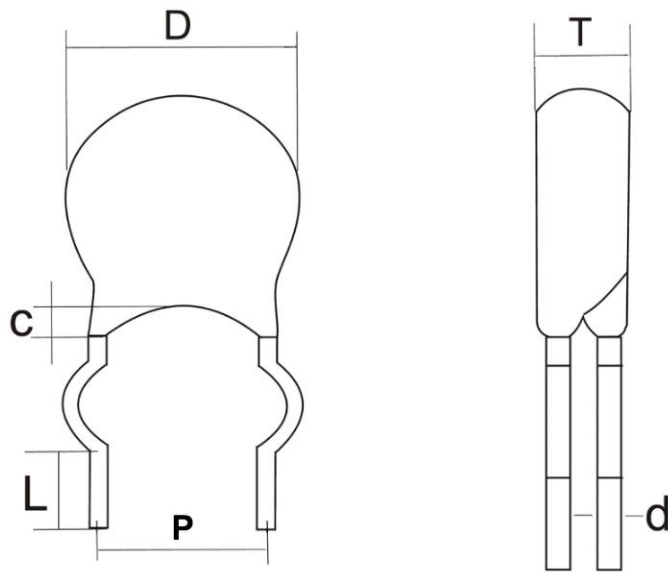

Code 0: Long straight lead



Code 2: Outside kink lead

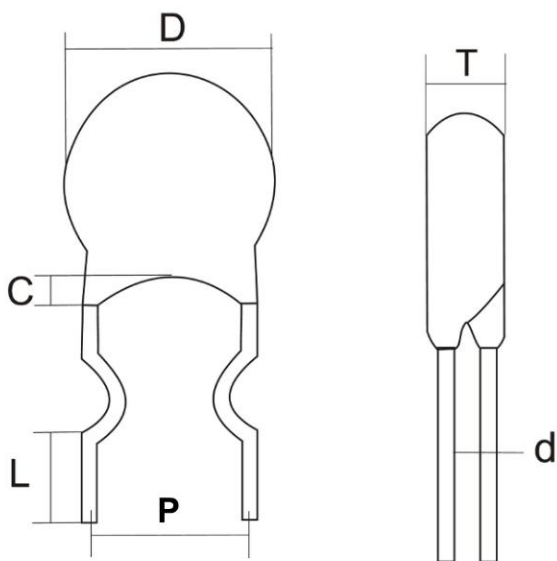

Code 4: inside kink lead

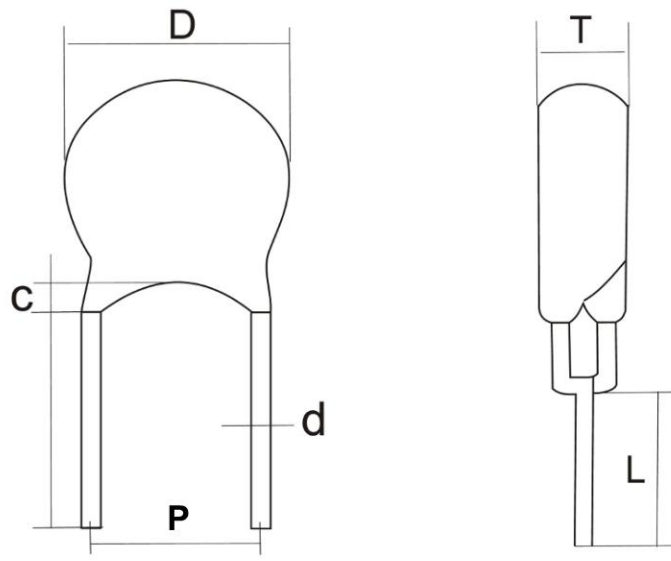

Code 8: Y kink lead

### CT81 HIGH VOLTAGE CERAMIC CAPACITOR

Item		500V				1 KV				2 KV				3 KV				Remark
Dielectric	Capacitance Code Tolerance Code	D±1	T±1	P±1	d± 0.05	D±1	T±1	P±1	d± 0.05	D±1	T±1	P±1	d± 0.05	D±1	T±1	P±1	d± 0.05	
NPO	1R0-9R0 D	5.5	2.2	5.0	0.5	5.5	2.2	5.0	0.5	6.0	2.3	5.0	0.5	6.0	3.5	7.5	0.7	
NPO	100 K	5.5	2.2	5.0	0.5	5.5	2.2	5.0	0.5	6.0	2.3	5.0	0.5	6.0	3.5	7.5	0.7	
SL	120-101K	5.5	2.2	5.0	0.5	5.5	2.2	5.0	0.5	6.0	2.8	5.0	0.5	6.0	3.5	7.5	0.7	
Y5P	120-101K	5.5	2.2	5.0	0.5	6.0	2.3	5.0	0.5	6.0	2.8	5.0	0.5	6.1	3.5	7.5	0.7	
Y5P	151-561K	6.0	2.2	5.0	0.5	6.0	2.3	5.0	0.5	6.0	3.0	5.0	0.5	6.0	3.5	7.5	0.7	
Y5U	102M	6.5	2.3	5.0	0.5	/	/	/	/	5.6	3.0	5.0	0.5	6.0	3.5	7.5	0.7	
Y5P	681-102K	6.0	2.2	5.0	0.5	6.5	2.3	5.0	0.5	8.0	3.0	5.0	0.5	9.1	3.5	7.5	0.7	
Y5V	122-222M	6.0	2.2	5.0	0.5	/	/	/	/	6.0	3.0	5.0	0.5	6.0	3.5	7.5	0.7	
Y5U	122-222M	6.0	2.2	5.0	0.5	7.0	2.3	5.0	0.5	8.0	3.0	5.0	0.5	9.1	3.5	7.5	0.7	
Y5P	122-222K	8.0	2.2	5.0	0.5	8.5	2.3	5.0	0.5	11.0	3.0	7.5	0.6	13.0	3.5	7.5	0.7	
Y5V	272-472M	6.0	2.2	5.0	0.5	6.5	2.5	5.0	0.5	8.0	3.0	7.5	0.6	9.0	3.5	7.5	0.6	
Y5U	272-472M	7.0	2.2	5.0	0.5	8.0	2.3	5.0	0.5	10.0	3.0	5.0	0.5	13.1	3.8	10.0	0.7	
Y5P	272-472K	11.0	2.2	5.0	0.5	12.0	2.3	5.0	0.5	14.4	3.0	7.5	0.6	/	/	/	/	
Y5P	562K	12.0	2.5	5.0	0.5	13.0	2.5	7.5	0.6	17.0	3.0	7.5	0.6	/	/	/	/	
Y5V	682-103M	8.0	2.2	5.0	0.5	9.0	2.3	5.0	0.5	10.0	3.0	7.5	0.6	11.0	3.5	7.5	0.7	
Y5U	682-103M	9.0	2.2	5.0	0.5	12.0	2.3	5.0	0.5	14.4	3.0	10.0	0.6	17.2	3.8	10.0	0.7	
Y5V	153-223M	11.0	2.2	5.0	0.5	13.5	2.5	7.5	0.6	15.0	3.5	10.0	0.6	/	/	/	/	
Y5V	473M	17.0	2.5	7.5	0.6	17.0	2.5	10.0	0.7	21.0	3.5	10.0	0.7	/	/	/	/	
Y5V	473M	15.0	2.3	7.5	0.5	17.5	2.5	10.0	0.7	21.0	3.5	10.0	0.7	/	/	/	/	
Y5V	104M Φ19	20.0	2.3	7.5	0.5	20.4	2.8	10.0	0.7	26.5	3.5	10.0	0.7	/	/	/	/	
Y5V	104M Φ24	23.5	2.3	7.5	0.5	22.4	2.8	10.0	0.7	26.5	3.5	10.0	0.7	/	/	/	/	

Item		4KV				5KV				6KV				Remark
Dielectric	Capacitance Code Tolerance Code	D±1	T±1	P±1	d± 0.05	D±1	T±1	P±1	d± 0.05	D±1	T±1	P±1	d± 0.05	
Y5P	101 K	6.0	3.0	7.5	0.6	6.0	3.5	10.0	0.6	6.0	3.5	10.0	0.6	
Y5P	151 K	6.0	3.5	7.5	0.6	6.0	4.5	10.0	0.6	6.0	4.5	10.0	0.6	
Y5P	221 K	6.0	3.5	7.5	0.6	6.0	4.5	10.0	0.6	6.0	4.5	10.0	0.6	
Y5P	271 K	7.0	3.5	7.5	0.6	6.0	4.5	10.0	0.6	6.0	4.5	10.0	0.6	
Y5P	331 K	6.5	3.5	7.5	0.6	7.0	4.5	10.0	0.6	7.0	4.5	10.0	0.6	
Y5U	331 K	/	/	/	/	6.0	4.5	10.0	0.6	6.0	4.5	10.0	0.6	
Y5P	471 K	6.5	3.5	7.5	0.6	8.0	4.5	10.0	0.7	8.0	4.5	10.0	0.7	
Y5U	471 K	/	/	/	/	6.0	4.5	10.0	0.6	6.0	4.5	10.0	0.6	
Y5P	561 K	7.0	3.5	7.5	0.6	9.0	4.5	10.0	0.7	9.0	4.5	10.0	0.7	
Y5U	561 K	/	/	/	/	7.0	4.5	10.0	0.6	7.0	4.5	10.0	0.6	
Y5P	681 K	7.5	3.5	7.5	0.6	9.0	4.5	10.0	0.7	9.0	4.5	10.0	0.7	
Y5P	102 K	9.0	3.5	7.5	0.6	11.0	4.5	10.0	0.7	11.0	4.5	10.0	0.7	
Y5U	102 M	6.0	3.5	7.5	0.6	7.0	4.5	10.0	0.6	7.0	4.5	10.0	0.6	
Y5V	102 M	/	/	/	/	6.0	4.5	10.0	0.6	6.0	4.5	10.0	0.6	
Y5U	152 M	8.0	3.5	7.5	0.6	9.0	4.5	10.0	0.6	9.0	4.5	10.0	0.6	
Y5V	152 M	6.0	3.5	7.5	0.6	7.0	4.5	10.0	0.6	7.0	4.5	10.0	0.6	
Y5U	222 M	9.0	3.5	7.5	0.6	10.0	4.5	10.0	0.7	10.0	4.5	10.0	0.7	
Y5V	222 M	7.0	3.5	7.5	0.6	8.0	4.5	10.0	0.7	8.0	4.5	10.0	0.7	
Y5U	332 M	11.0	3.5	7.5	0.6	13.5	4.5	10.0	0.7	13.5	4.5	10.0	0.7	
Y5V	332 M	8.0	3.5	7.5	0.6	10.0	4.5	10.0	0.7	10.0	4.5	10.0	0.7	
Y5U	472 M	13.0	3.5	10.0	0.7	16.5	5.0	10.0	0.7	16.5	5.0	10.0	0.7	
Y5V	472 M	9.0	3.5	7.5	0.6	11.0	4.5	10.0	0.7	11.0	4.5	10.0	0.7	
Y5U	103 M	17.5	3.5	10.0	0.7	/	/	/	/	18.5	4.5	10.0	0.7	
Y5V	103 M	13.5	3.5	10.0	0.7	/	/	/	/	/	/	/	/	
Y5V	203 M	20.5	3.5	10.0	0.7	/	/	/	/	/	/	/	/	
Y5V	223 M	20.5	3.5	10.0	0.7	/	/	/	/	/	/	/	/	

Ammo Taped and Cut Leads are available on request. Special size is on request too.  
 Please consult to sales if you need higher voltage than 6KV or other values.